

GP Batteries

Data Sheet

Model No.: CR2016

Description : Flat Lithium Battery
 Chemical system : Lithium Manganese Dioxide
 Nominal voltage : 3 Volts
 Nominal capacity : 90mAh
 Dimensions : $\varnothing 20.0 \times 1.6$ mm
 Shelf life : 5 years at room temperature
 Average weight : 1.7 grams
 Applications : Computer memory back up,
 photo

Discharge Characteristics on Load

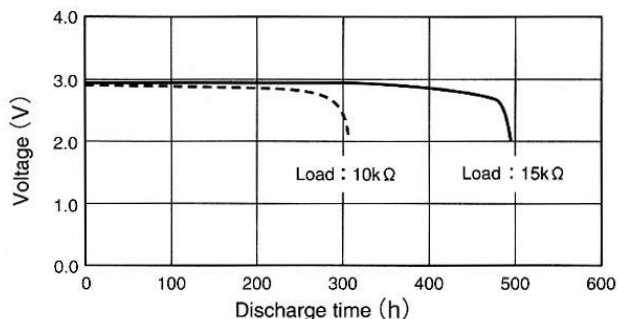

Discharge Characteristics on Temperature

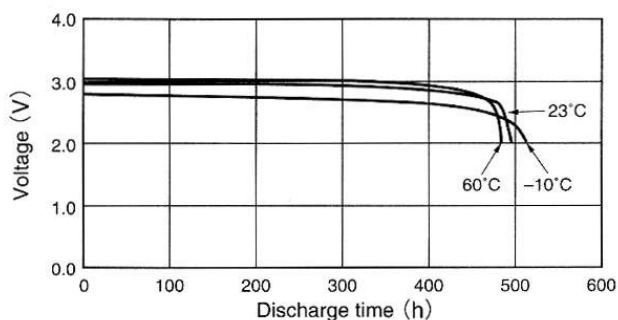

Discharge Characteristics on Pulse Load

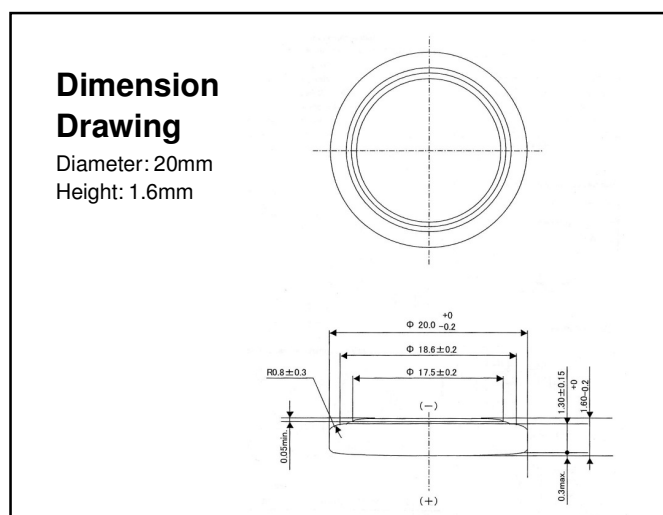
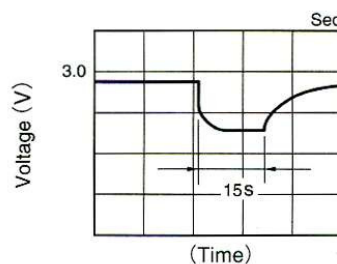
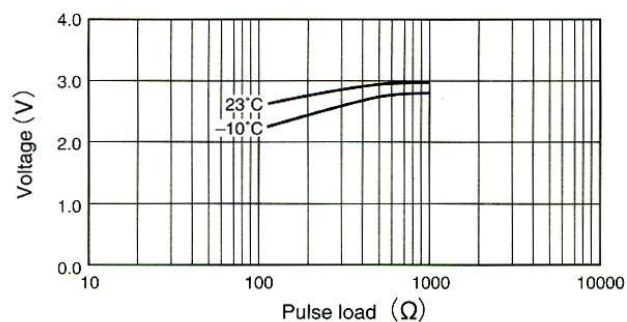

Discharge Load vs. Discharge Capacity

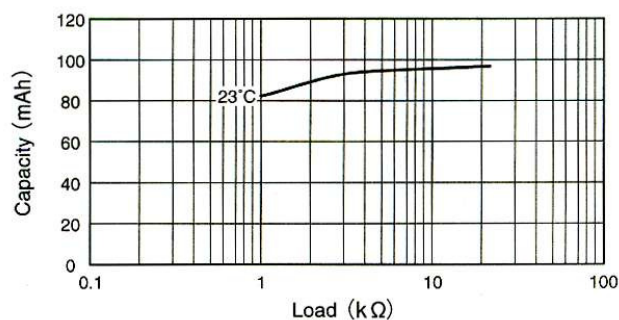

Cross References:

IEC	JIS	Eveready	Varta	Duracell
CR2016	CR2016	ECR2016	CR2016	DL2016